



SALOTEHNIK d.o.o.

Rezni alati i pribor

Inovatools EconomyLine
do 15% još povoljnije!!!

2017

sij velj ožu tra svi lip srp kol ruj lis stu pro

www.salotehnik.hr

TM GLODALA

TM SVRDLA 4xD/5xD/6xD

NAJMANJA NARUDŽBA 1.500,- kn neto!
ZA NARUDŽBE 4.000,- kn neto popust 15%!
Akcija traje do 3/2018!

AKCIJA!!!
-%



-10%
-15%

-10%

ECONOMY - LINE

InovaTools **EE**
GERMAN TOOLS GROUP

ARNO[®]
WERKZEUGE

ZA SVE MATERIJALE!!!

P	M	K	N	S	H
●	●	●	●	●	●

ARTIKEL-NR.
924.5...

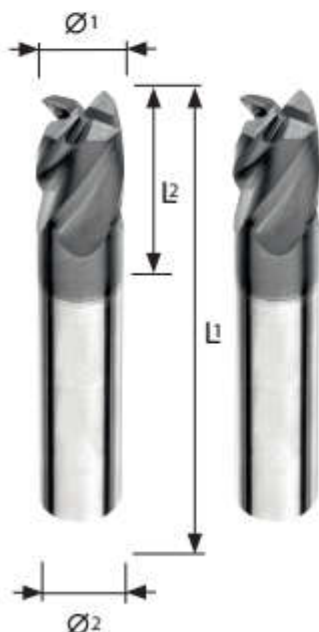

Ø1	Ø2	L2	L1	Z	Artikel-Nr.	€/Stk
1,00	6,00	3	50	4	924.501...	9,5
2,00	6,00	4	50	4	924.502...	9,5
3,00	6,00	6	50	4	924.503...	9,5
4,00	6,00	8	50	4	924.504...	9,5
5,00	6,00	8	50	4	924.505...	10,1
6,00	6,00	13	57	4	924.506...	11,1
8,00	8,00	19	63	4	924.508...	16,0
10,00	10,00	22	72	4	924.510...	21,4
12,00	12,00	26	83	4	924.512...	30,8
16,00	16,00	32	92	4	924.516...	51,5
20,00	20,00	38	104	4	924.520...	80,3

Bitte fügen Sie bei Ihrer Bestellung folgende Codes hinzu: mit Weldon .10 ohne Weldon



ARTIKEL-NR.
953.2 ...

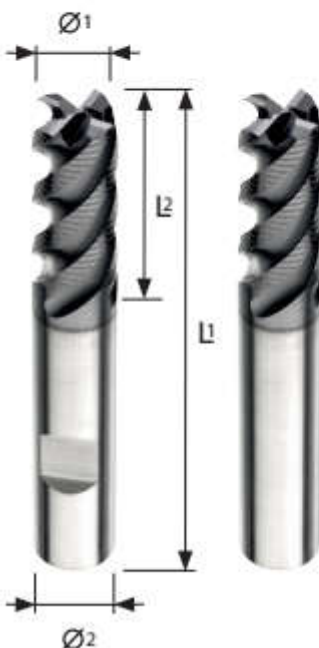

Ø1	Ø2	L2	L1	Z	Artikel-Nr.	€/Stk
4,00	6,00	11	57	3	953.204...	12,9
5,00	6,00	13	57	4	953.205...	12,9
6,00	6,00	16	57	4	953.206...	14,1
8,00	8,00	16	69	4	953.208...	18,4
10,00	10,00	22	72	4	953.210...	25,6
12,00	12,00	28	83	4	953.212...	37,4
16,00	16,00	32	92	5	953.216...	62,8
20,00	20,00	38	104	6	953.220...	105,3

Bitte fügen Sie bei Ihrer Bestellung folgende Codes hinzu: mit Weldon .10 ohne Weldon



**NAJMANJA NARUDŽBA 1.500,- kn neto! 1 EUR=7,60 HRK
ZA NARUDŽBE GLODALA IZNAD 4.000,- kn neto popust 15%!**

ARTIKEL-NR.

927 ...

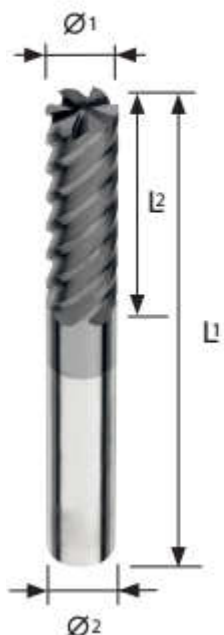

Ø1	Ø2	L2	L1	Z	Artikel-Nr.	€/Stk
6,00	6,00	26	70	6	927.060.00	17,2
8,00	8,00	36	90	6	927.080.00	22,0
10,00	10,00	46	100	6	927.100.00	33,9
12,00	12,00	56	110	6	927.120.00	42,1
16,00	16,00	66	130	6	927.160.00	88,5
20,00	20,00	76	140	8	927.200.00	118,4



ARTIKEL-NR.

928 ...



Ø1	Ø2	L2	L1	Eckfase Chamfer	Z	Artikel-Nr.	€/Stk
2,00	6,00	8	57	0,05	4	928.002.00	9,6
3,00	6,00	14	57	0,05	4	928.003.00	9,6
4,00	6,00	18	57	0,10	4	928.004.00	9,6
5,00	6,00	20	57	0,10	4	928.005.00	12,5
6,00	6,00	22	57	0,10	4	928.006.00	13,6
8,00	8,00	30	63	0,15	4	928.008.00	17,0
10,00	10,00	33	72	0,15	4	928.100.00	24,9
12,00	12,00	34	83	0,20	4	928.120.00	32,9
16,00	16,00	38	92	0,20	4	928.160.00	58,9
20,00	20,00	47	104	0,30	4	928.200.00	85,0



**NAJMANJA NARUDŽBA 1.500,- kn neto! 1 EUR=7,60 HRK
ZA NARUDŽBE GLODALA IZNAD 4.000,- kn neto popust 15%!**

ARTIKEL-NR.
973.2 ...

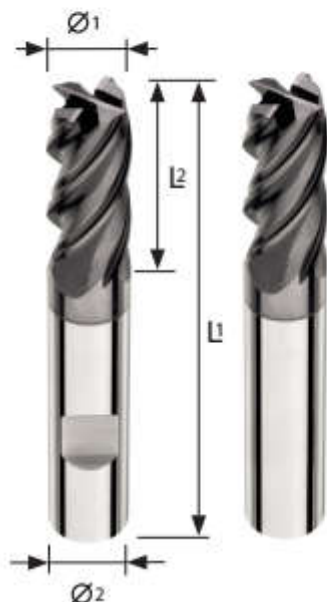

Ø1	Ø2	L2	L1	Eckfase Chamfer	Z	Artikel-Nr.	€/Stk
3,00	6,00	8	57	0,10	4	973.203...	12,9
4,00	6,00	11	57	0,13	4	973.204...	12,9
5,00	6,00	13	57	0,18	4	973.205...	12,9
6,00	6,00	13	57	0,20	4	973.206...	14,1
8,00	8,00	19	63	0,20	4	973.208...	19,1
10,00	10,00	22	72	0,30	4	973.210...	25,0
12,00	12,00	26	83	0,30	4	973.212...	35,0
14,00	14,00	26	83	0,30	4	973.214...	43,6
16,00	16,00	32	92	0,40	4	973.216...	55,0
18,00	18,00	32	92	0,40	4	973.218...	65,7
20,00	20,00	38	104	0,50	4	973.220...	85,1

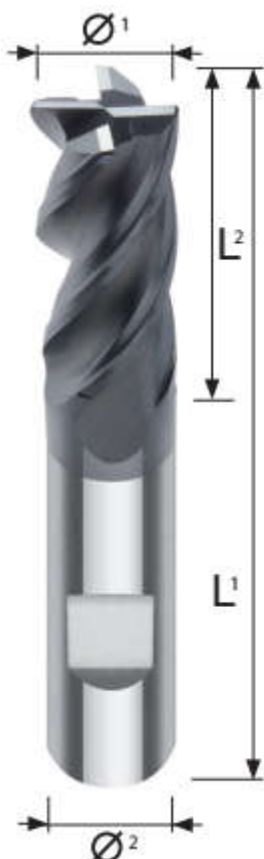

ARTIKEL-NR.
1.389...

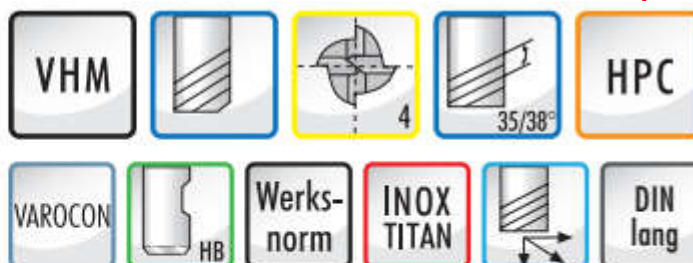

Ø1	Ø2	L2	L1	Eckfase Corner chamfer	Z	Artikel-Nr.	€/Stk
6,00	6,00	13	57	0,2	4	1.389.060.10	16,00
8,00	8,00	19	63	0,2	4	1.389.080.10	20,80
10,00	10,00	22	72	0,2	4	1.389.100.10	30,60
12,00	12,00	26	83	0,3	4	1.389.120.10	41,80
16,00	16,00	32	92	0,3	4	1.389.160.10	65,90
20,00	20,00	38	104	0,4	4	1.389.200.10	102,00



**NAJMANJA NARUDŽBA 1.500,- kn neto! 1 EUR=7,60 HRK
ZA NARUDŽBE GLODALA IZNAD 4.000,- kn neto popust 15%!**

TM SPIRALNA SVRDLA Ø1,0-Ø20,0 SA HLAĐENJEM



4xD bez hlađenja INOVATOOLS EconomyLine tip 504.

5xD sa hlađenjem ARNO tip SPC0... VHM/TIALN

6xD sa hlađenjem INOVATOOLS EconomyLine tip 614.

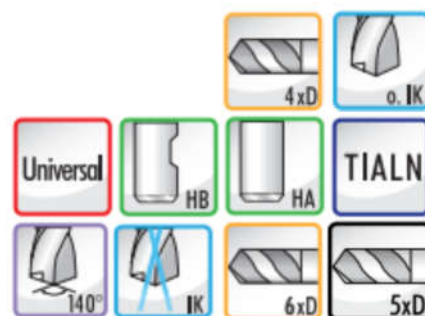
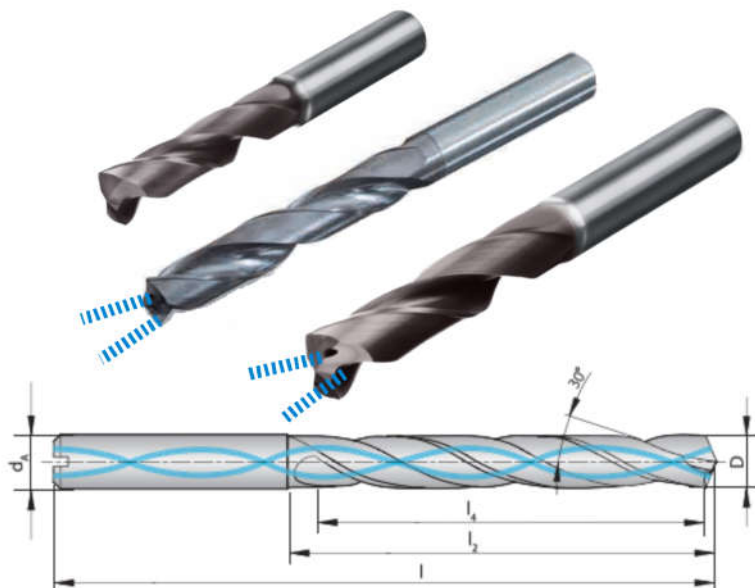

	RASPON PROMJERA	4XD STANDARD EUR/kom	5XD SA HLAĐENJEM EUR/kom	6XD SA HLAĐENJEM EUR/kom
1	Ø1,00- Ø2,90	26,30	31,40	41,10
2	Ø3,00- Ø6,00	21,60	34,15	38,00
3	Ø6,10- Ø8,00	22,60	38,80	43,20
4	Ø8,10- Ø10,00	25,60	45,10	48,30
5	Ø10,10- Ø12,00	37,10	62,15	68,90
6	Ø12,20- Ø14,00	49,30	85,60	93,70
7	Ø14,20- Ø16,00	63,90	104,10	118,50
8	Ø16,50- Ø18,00	100,80	160,00	187,50
9	Ø18,50- Ø20,00	119,40	172,90	205,00



**NAJMANJA NARUDŽBA 1.500,- kn neto! 1 EUR=7,60 HRK
SVRDLA 4xD/6xD-10%, ARNO 5xD neto!**



SALOTEHNIK d.o.o.
Rezni alati i pribor
Kneza Zdeslava 11
Lug Samoborski
HR-10432 Bregana
www.salotehnik.hr
info@salotehnik.hr
+385 95 836 1466

